

IK-4248TH-MH/PL HiLook 4K PoE Turret Kit



- One pack contains everything required for small monitoring scenarios
- Up to 1-ch@8 MP/3-ch@4 MP/6-ch@1080p decoding capacity
- Four 4K Fixed Turret network cameras with efficient H.265 compression technology
- One 4K HiLook 4-Channel NVR
- Red and blue strobe light with Siren
- 2-Way Audio
- 2 TB pre-installed HDD

▪ Specification

Camera	
Camera	
Camera Case Type	Turret
Image Sensor	1/2.7" Progressive Scan CMOS
Min. Illumination	Color: 0.01 Lux @ (F2.0, AGC ON),B/W: 0 Lux with IR
Shutter Speed	1/3 s to 1/100,000 s
Day & Night	IR cut filter
Angle Adjustment	Pan: 0° to 360°, tilt: 0° to 75°, rotation: 0° to 360°
Protection Level	IP67
Material	Camera body: metal, bottom base : plastic
Wi-Fi Support	No
Lens	
Focal Length	2.8 mm
Aperture	F2.0
Focus	Fixed
FOV	horizontal FOV 113°, vertical FOV 62°, diagonal FOV 134°
Lens Mount	M12
IR Range	Up to 30 m
Video	
Video Compression	Main stream: H.265+/H.265/H.264+/H.264, Sub-stream: H.265/H.264/MJPEG
H.264 Type	Baseline Profile, Main Profile, High Profile
H.264+	No
H.265 Type	Main Profile
H.265+	No
Video Bit Rate	32 Kbps to 16 Mbps
Max. Resolution	3840 × 2160
Main Stream	50 Hz: 12.5 fps (3840 × 2160, 3200 × 1800, 2688 × 1520, 1920 × 1080, 1280 × 720) 60 Hz: 15 fps (3840 × 2160, 3200 × 1800, 2688 × 1520, 1920 × 1080, 1280 × 720)
Sub-stream	50 Hz: 12.5 fps (1280 × 720, 640 × 480, 640 × 360) 60 Hz: 15 fps (1280 × 720, 640 × 480, 640 × 360)
Image Setting	H.264 Type
Day/Night Switch	Day, Night, Auto, Schedule
Network	
Alarm Trigger	Motion detection, video tampering alarm, illegal login
Protocols	TCP/IP, ICMP, DHCP, DNS, HTTP, RTP, RTSP, RTCP, NTP, IGMP, IPv4, IPv6, UDP, QoS, FTP, SMTP
General Function	Heartbeat, anti-banding, mirror, password protection, password reset via email
Client	iVMS-4200, HiLookVision
Interface	
Communication Interface	1 RJ45 10M/100M self-adaptive Ethernet port
On-board Storage	N/A

Video Out	No
Reset Button	No
General	
Power Supply	12 VDC \pm 25%, Φ 5.5 mm coaxial plug power, or PoE (802.3af, class 3)
Consumption	12 VDC, 0.3 A, Max: 3.5 W, or PoE (802.3af, 36 V to 57 V), 0.2 A to 0.1 A, Max: 4.5 W
Working Temperature	-30 °C to 60 °C (-22 °F to 140 °F)
Working Humidity	95% or less (non-condensing)
Dimension (W \times D \times H)	Φ 110 mm \times 93.2 mm (4.3" \times 3.7")
Weight	Approx. 360 g (0.8 lb)
NVR	
Video and Audio	
IP Video Input	4-ch
Incoming/Outgoing Bandwidth	40 Mbps/80 Mbps
HDMI Output	1-ch, 4K (3840 \times 2160)/30Hz, 1920 \times 1080p/60Hz, 1600 \times 1200/60Hz, 1280 \times 1024/60Hz, 1280 \times 720/60Hz, 1024 \times 768/60Hz HDMI/VGA simultaneous output
VGA Output	1-ch, 1920 \times 1080p/60Hz, 1600 \times 1200/60Hz, 1280 \times 1024/60Hz, 1280 \times 720/60Hz, 1024 \times 768/60Hz ;HDMI/VGA simultaneous output
Video Output Mode	HDMI/VGA simultaneous output
Audio Output	1-ch, RCA (Linear, 1 K Ω)
Two-Way Audio	1-ch, RCA (2.0 Vp-p, 1 K Ω)
Decoding	
Decoding Format	H.265+,H.265,H.264+,H.264
Video Resolution	8 MP/6 MP/5 MP/4 MP/3 MP/1080p/UXGA/ 720p/VGA/4CIF/DCIF/2CIF/CIF/QCIF
Synchronous Playback	4-ch
Capability	1-ch@8 MP (30 fps)/3-ch@4 MP (30 fps)/6-ch@1080p (30 fps)
Network	
Network Interface	1, RJ-45 10/100 Mbps self-adaptive Ethernet interface
Network Protocol	TCP/IP, DHCP, IPv4, IPv6, DNS, DDNS, NTP, RTSP, SADP, SMTP, SNMP, NFS, iSCSI, ISUP, UPnP™, HTTP, HTTPS
Remote Connection	32
PoE	
Interface	4-ch, RJ-45 10/100 Mbps self-adaptive Ethernet interface
Power	\leq 50 W
Standard	IEEE 802.3 af/at
Auxiliary interface	
SATA	1 SATA interface
Capacity	Up to 8 TB capacity for each disk
USB Interface	2 \times USB 2.0
Alarm In/Out	No
General	
Power Supply	48 VDC, 1.35 A
Consumption (without HDD and PoE off)	\leq 10 W (without HDD and PoE off)
Working Temperature	-10 to +55° C (14 to 131° F)

Working Humidity	10% to 90%
Dimension (W × D × H)	265 × 225 × 48 mm (10.2" × 8.9" × 1.9")
Weight (without hard disk)	≤ 1 kg (without HDD, 2.2 lb.)
Kit	
Weight (with package)	≤ 7.5 kg (16.5 lb)

Physical Interface

No.	Description	No.	Description
1	Network Interfaces with PoE Function	6	VGA Interface
2	LAN Interface	7	USB Interface.
3	AUDIO OUT	8	Power supply
4	AUDIO IN	9	Power Switch
5	HDMI Interface	10	GND

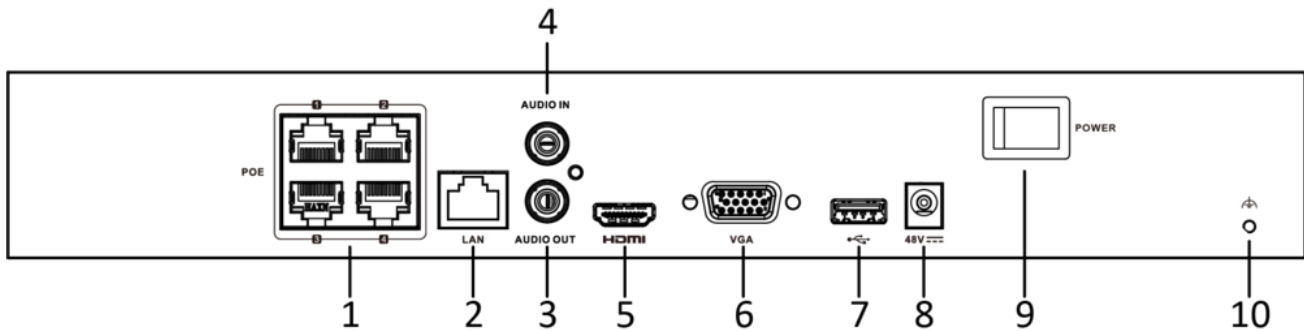

▪ Available Model

DS-J142I(STD)/CAN/IK-4248TH-MH/PL

▪ Dimension

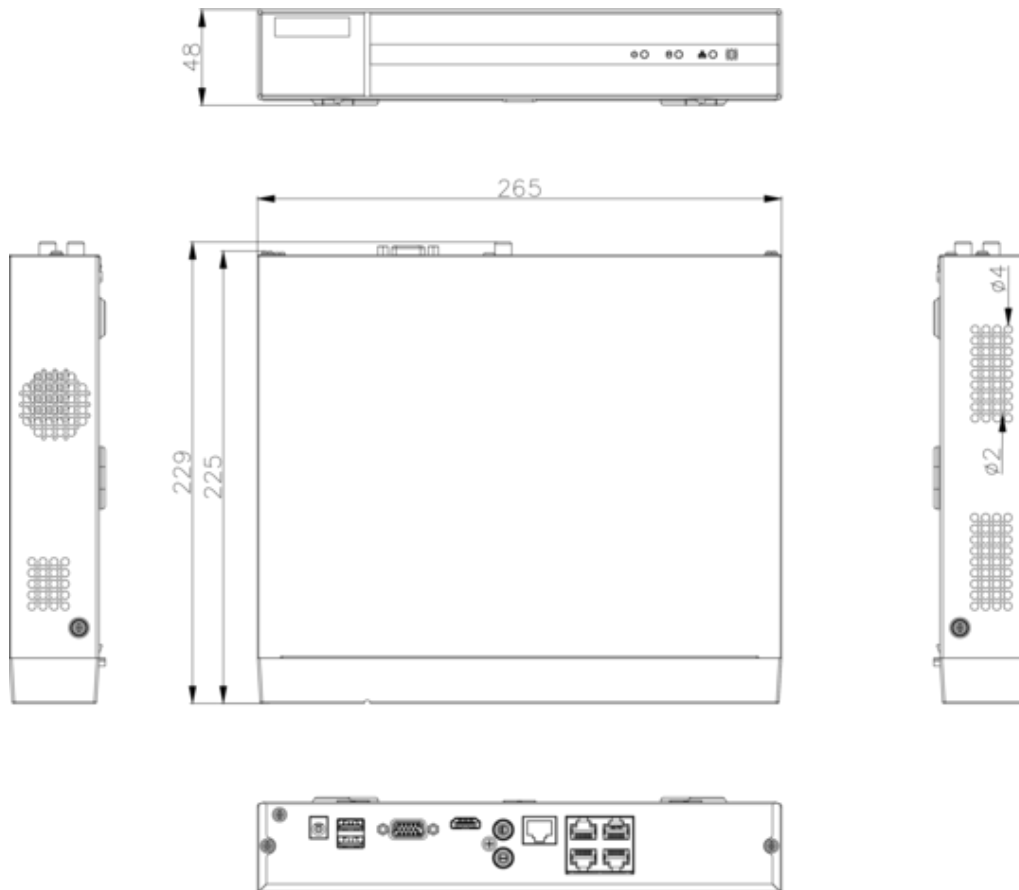



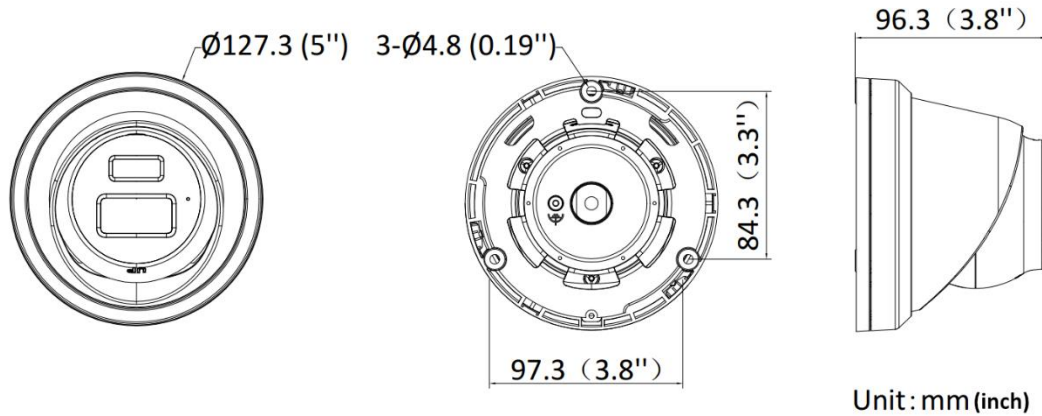







scale/1:1;Unit/mm

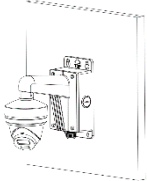
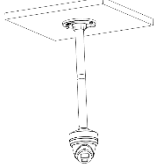
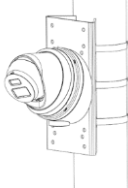

Accessory

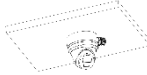
▪ Optional

DS-1273ZJ-130B-TRL Wall mount	DS-1271ZJ-130-TRL Pendant Mount	DS-1275ZJ-SUS Vertical pole mount	DS-1276ZJ-SUS Corner mount
			
			
DS-1280ZJ-DM8 Junction box	DS-1281ZJ-M Inclined ceiling mount		
			
			

HiLook

Headquarters

No.555 Qianmo Road, Binjiang District,
Hangzhou 310051, China
T +86-571-8807-5998
Technical Support: support@hikvision.com

Follow us on social media to get the latest product and solution information.

