



Body Camera

Quick Start Guide

About this Document

- This Document includes instructions for using and managing the Product. Pictures, charts, images and all other information hereinafter are for description and explanation only.
- The information contained in the Document is subject to change, without notice, due to firmware updates or other reasons. Please find the latest version of the Document at the Hikvision website (<https://www.hikvision.com>). Unless otherwise agreed, Hangzhou Hikvision Digital Technology Co., Ltd. or its affiliates (hereinafter referred to as "Hikvision") makes no warranties, express or implied.
- Please use the Document with the guidance and assistance of professionals trained in supporting the Product.

About this Product

This product can only enjoy the after-sales service support in the country or region where the purchase is made.

Acknowledgment of Intellectual Property Rights

- Hikvision owns the copyrights and/or patents related to the technology embodied in the Products described in this Document, which may include licenses obtained from third parties.
- Any part of the Document, including text, pictures, graphics, etc., belongs to Hikvision. No part of this Document may be excerpted, copied, translated, or modified in whole or in part by any means without written permission.
- **HIKVISION** and other Hikvision's trademarks and logos are the properties of Hikvision in various jurisdictions.
- Other trademarks and logos mentioned are the properties of their respective owners.

LEGAL DISCLAIMER

- TO THE MAXIMUM EXTENT PERMITTED BY APPLICABLE LAW, THIS DOCUMENT AND THE PRODUCT DESCRIBED, WITH ITS HARDWARE, SOFTWARE AND FIRMWARE, ARE PROVIDED "AS IS" AND "WITH ALL FAULTS AND ERRORS". HIKVISION MAKES NO WARRANTIES, EXPRESS OR IMPLIED, INCLUDING WITHOUT LIMITATION, MERCHANTABILITY, SATISFACTORY QUALITY, OR FITNESS FOR A PARTICULAR PURPOSE. THE USE OF THE PRODUCT BY YOU IS AT YOUR OWN RISK. IN NO EVENT WILL HIKVISION BE LIABLE TO YOU FOR ANY SPECIAL, CONSEQUENTIAL, INCIDENTAL, OR INDIRECT DAMAGES, INCLUDING, AMONG OTHERS, DAMAGES FOR LOSS OF BUSINESS PROFITS, BUSINESS INTERRUPTION, OR LOSS OF DATA, CORRUPTION OF SYSTEMS, OR LOSS OF DOCUMENTATION, WHETHER BASED ON BREACH OF CONTRACT, TORT (INCLUDING NEGLIGENCE), PRODUCT LIABILITY, OR OTHERWISE, IN CONNECTION WITH THE USE OF THE PRODUCT, EVEN IF HIKVISION HAS BEEN ADVISED OF THE POSSIBILITY OF SUCH DAMAGES OR LOSS.
- YOU ACKNOWLEDGE THAT THE NATURE OF THE INTERNET PROVIDES FOR INHERENT SECURITY



RISKS, AND HIKVISION SHALL NOT TAKE ANY RESPONSIBILITIES FOR ABNORMAL OPERATION, PRIVACY LEAKAGE OR OTHER DAMAGES RESULTING FROM CYBER-ATTACK, HACKER ATTACK, VIRUS INFECTION, OR OTHER INTERNET SECURITY RISKS; HOWEVER, HIKVISION WILL PROVIDE TIMELY TECHNICAL SUPPORT IF REQUIRED.

- YOU AGREE TO USE THIS PRODUCT IN COMPLIANCE WITH ALL APPLICABLE LAWS, AND YOU ARE SOLELY RESPONSIBLE FOR ENSURING THAT YOUR USE CONFORMS TO THE APPLICABLE LAW. ESPECIALLY, YOU ARE RESPONSIBLE, FOR USING THIS PRODUCT IN A MANNER THAT DOES NOT INFRINGE ON THE RIGHTS OF THIRD PARTIES, INCLUDING WITHOUT LIMITATION, RIGHTS OF PUBLICITY, INTELLECTUAL PROPERTY RIGHTS, OR DATA PROTECTION AND OTHER PRIVACY RIGHTS. YOU SHALL NOT USE THIS PRODUCT FOR ANY PROHIBITED END-USES, INCLUDING THE DEVELOPMENT OR PRODUCTION OF WEAPONS OF MASS DESTRUCTION, THE DEVELOPMENT OR PRODUCTION OF CHEMICAL OR BIOLOGICAL WEAPONS, ANY ACTIVITIES IN THE CONTEXT RELATED TO ANY NUCLEAR EXPLOSIVE OR UNSAFE NUCLEAR FUEL-CYCLE, OR IN SUPPORT OF HUMAN RIGHTS ABUSES.
- IN THE EVENT OF ANY CONFLICTS BETWEEN THIS DOCUMENT AND THE APPLICABLE LAW, THE LATTER PREVAILS.

© Hangzhou Hikvision Digital Technology Co., Ltd. All rights reserved.

Symbol Conventions

The symbols that may be found in this document are defined as follows.

Symbol	Description
 Note	Provides additional information to emphasize or supplement important points of the main text.
 Caution	Indicates a potentially hazardous situation, which if not avoided, could result in equipment damage, data loss, performance degradation, or unexpected results.
 Danger	Indicates a hazard with a high level of risk, which if not avoided, will result in death or serious injury.

Chapter 1 Product Introduction

1.1 Introduction

Body camera (hereinafter referred to as device) highly integrates with record, taping, capture, positioning, etc. It is embedded with positioning module with high sensitivity to locate the occurring position of events accurately. It can record the process and condition of events completely via record, taping, and capture. It supports DIS (Digital Image Stabilization) to improve the image stabilization.

It is widely applicable to public security protection, traffic police enforcement, fire safety inspection, city management, tobacco law enforcement, etc.

1.2 Packing List

When you receive the product, check whether there is obvious damage on the product package and its appearance first. Then open the package and check whether all the accessories are included. If something loses, contact us or our supplier.

Table 1-1 Packing List

No.	Name	Quantity
1	Body camera	1
2	Shoulder clip	1
3	USB data cable	1
4	Power adaptor	1
5	SIM card pick-up tool	1
6	Regulatory compliance and safety information	1

1.3 Appearance

Refer to the figure and table below for the appearance of the device.

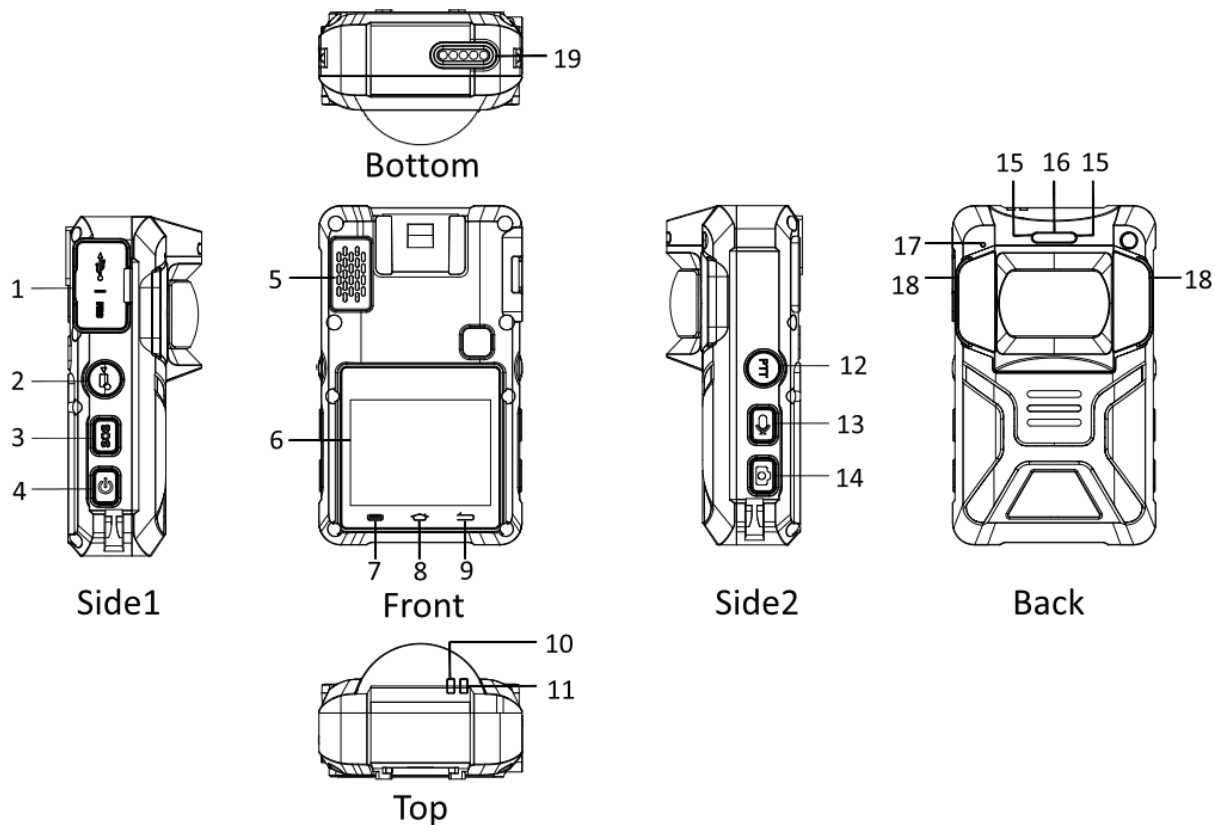





Figure 1-1 Appearance

Table 1-1 Appearance Description

No.	Name	Description
1	Type-C USB interface and SIM card slot plug	Open the plug to connect to data cable or insert a SIM card.
2	Recording button	<ul style="list-style-type: none"> After the device starts up, press it to start recording. Then press it again to stop recording. When the device is shut down, hold it to start it up and start recording.
3	SOS button	After the device starts up, press it to send the alarm signal to the connected platform manually.
4	On/Off button	<ul style="list-style-type: none"> When the device is off, hold it to start it up. When the device is on, hold it to shut it down. After the device starts up, press it to sleep or wake up the screen

No.	Name	Description
		display.
5	Loudspeaker	For sound play.
6	Screen	For interface display and operation.
7		In live view mode, tap it to enter the main menu.
8		Tap it to go to the live view page.
9		Tap it to return to the upper menu.
10	LED 1	<ul style="list-style-type: none"> ● Solid red: The device is being charged. ● Solid green: The device is fully charged. ● Flashing red (high frequency): The device is in low battery. ● Flashing red (low frequency): The device is recording.
11	LED 2	<ul style="list-style-type: none"> ● Solid green: The device is running. ● Flashing yellow (low frequency): The device is recording audio.
12	PTT button	After the device starts up, hold it to set the device as a MIC or loudspeaker to start two-way audio.
13	Audio recording button	After the device starts up, press it to start taping. Then press it again to stop taping.
14	Capture button	After the device starts up, press it once to capture a picture.
15	IR lights	<ul style="list-style-type: none"> ● If you set IR as On, the IR lights will be enabled during recording or remote live view. ● If you set IR as Auto, the IR lights will be enabled automatically during recording or remote live view when the illumination is insufficient.
16	LED light	<p>After the device starts up, hold the audio recording button to turn on LED light for light supplement or emergency illumination. Then hold it again to turn off LED light.</p> <p> Note</p> <p>If you turn on LED light while IR function is enabled already, the IR function will be disabled forcedly. After you turn off LED light, the IR function will restore to be enabled.</p>
17	MIC	For sound collection.
18	Flash light	Hold the SOS button to make it flashing in red and blue alternately for warning.
19	Expansion interface	Reserved.

Chapter 2 Installation

2.1 Install Shoulder Clip

Install the shoulder clip if you want to wear the device on your shoulder.

Step 1 Parallel the sheet metal buckle of the shoulder clip with the shoulder clip slot on the front panel of the device, and insert the shoulder clip into the slot as the direction shown below.

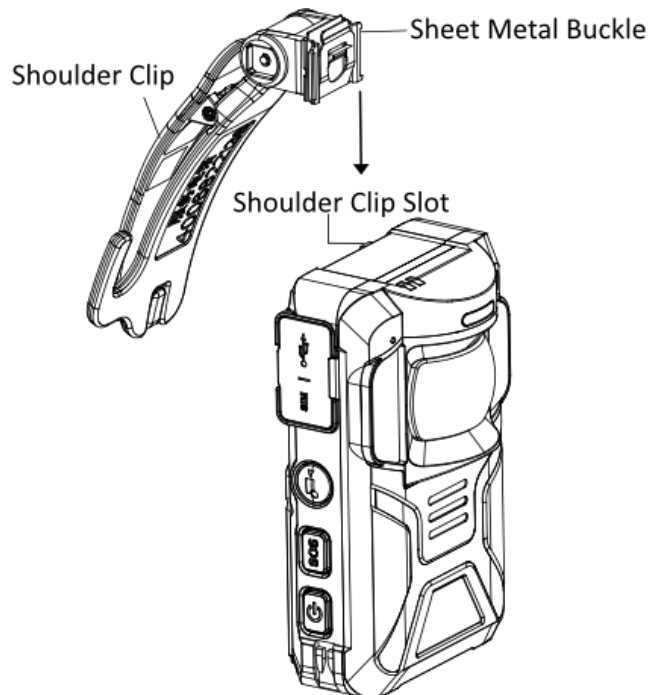

Figure 2-1 Install Shoulder Clip

Step 2 Push the shoulder clip downward until it is installed firmly.

Step 3 Optional: If you want to uninstall the shoulder clip, hold the shoulder clip and squeeze the spring strip outward. Parallel the shoulder clip to the shoulder clip slot and slide it upward to uninstall it.



Figure 2-2 Uninstall Shoulder Clip

2.2 Install SIM Card

Install a SIM card if you want to connect to network via SIM card.

Before You Start:

Prepare the SIM card.

 **Note**

Be sure to use a standard Nano-SIM card. Otherwise, the SIM card or the device may be damaged.

Step 1 Open the card slot plug on the side of the device.

Step 2 Insert the SIM card into the card slot in the direction indicated until it is installed firmly.

 **Note**

Use the SIM card pick-up tool to take out the SIM card as required.

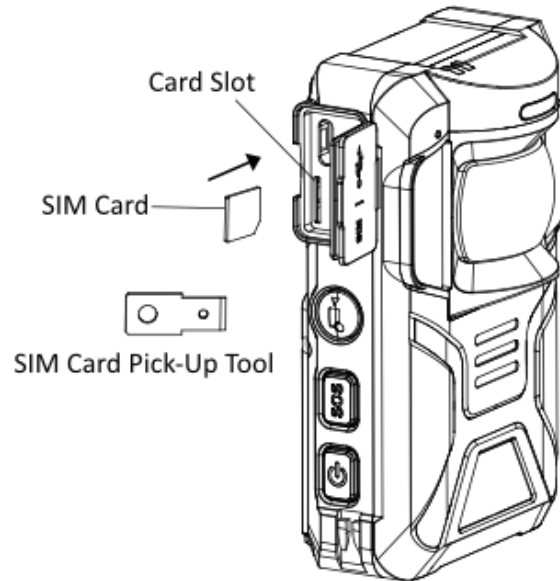

Figure 2-3 Install SIM Card

Step 3 Close the card slot plug.

2.3 Charge

When the device is in low battery, charge it in time.

Step 1 Open the USB interface plug on the side of the device.

Step 2 Connect the power adaptor to the USB data cable. Then connect the USB data cable to the device and connect the power adaptor to the charger to charge the device.

2.4 Install Body Camera Assistant

Install Body Camera Assistant (hereinafter referred to as software) if you want to configure the device parameters, download files, etc. via the computer.

Note

Install "BodyCameraAssistant-win32.exe" if your computer is in 32-bit operating system. Install "BodyCameraAssistant-win64.exe" if your computer is in 64-bit operating system.

Step 1 Get the installation file, and double click it.

Step 2 Select the software saving path, and click **Next**.

Note

The software is installed in C disk by default. You can click **Browse** to change the saving path.

Step 3 Click **Next**.

Step 4 Check **Create a desktop icon** according to your needs, and click **Next**.

Step 5 Click **Install**.

Step 6 Click **Next** to install the software drive.

Step 7 Click **Finish**.

Step 8 Click **Finish** to run the software.

Chapter 3 Detailed Configuration

Scan the QR code below to get the user manual for detailed configuration.



Figure 3-1 User Manual QR Code

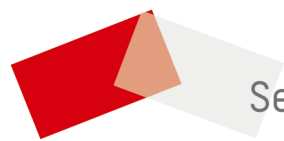

See Far, Go Further